

HP 9133A/B, 9134A/B, and 9135A Disc Memory User's Manual

 HEWLETT
PACKARD

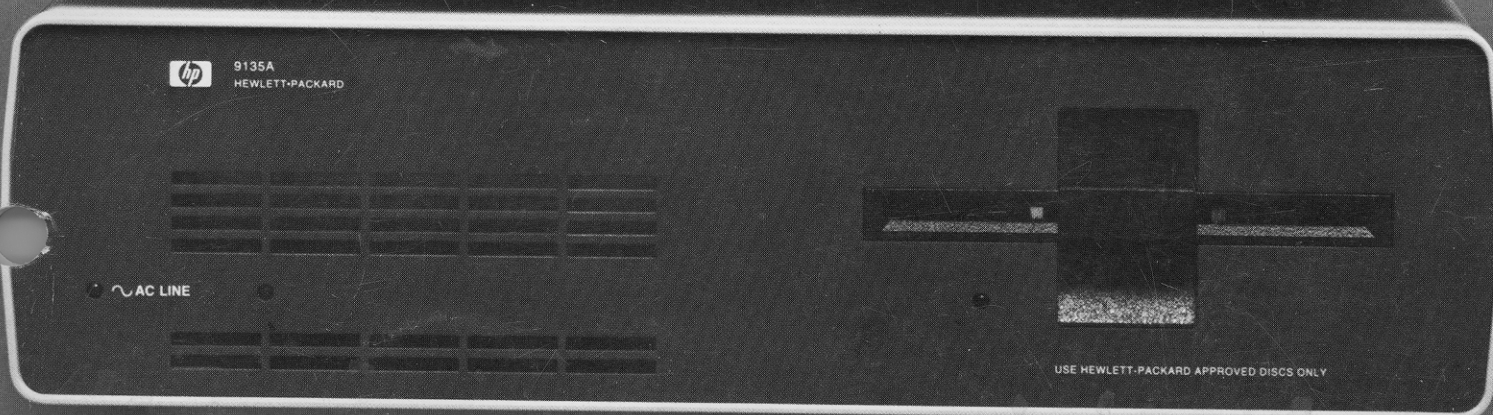
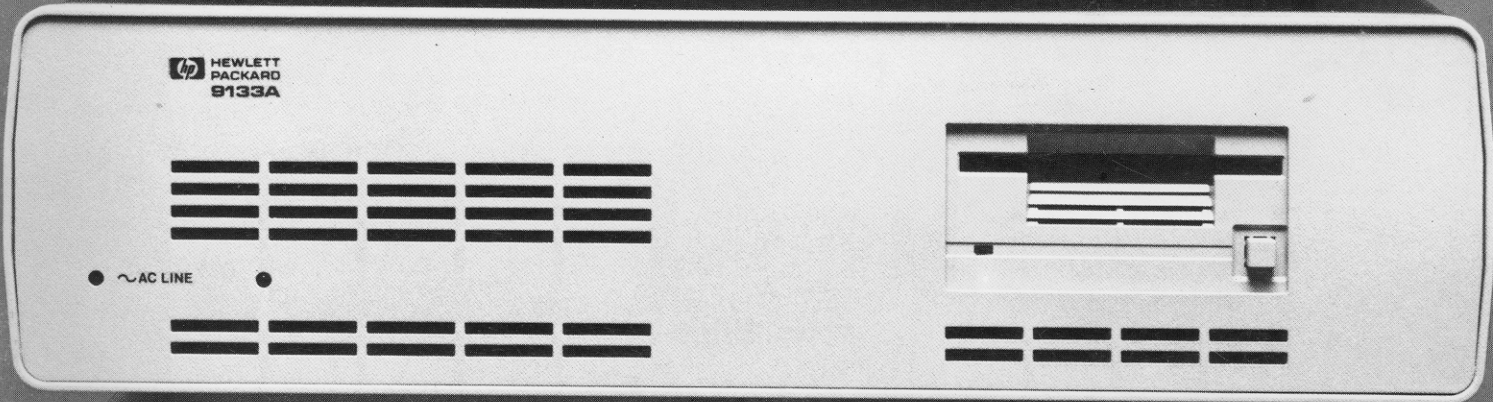
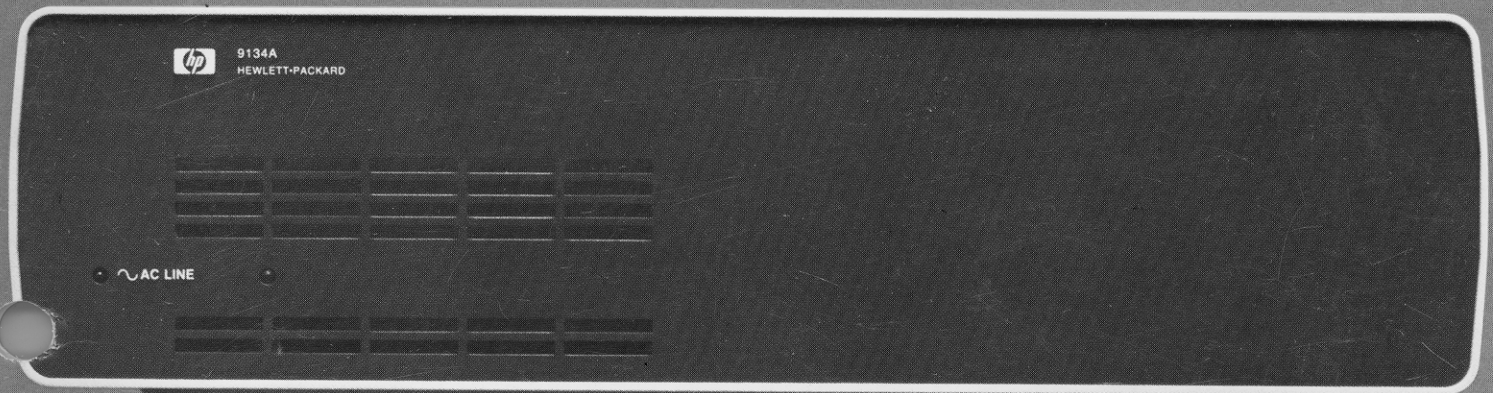

**HP 9133A/B, 9134A/B, and 9135A
Disc Memory User's Manual**

Hewlett-Packard Greeley Division
3404 E. Harmony Road, Fort Collins Colorado 80525

Table of Contents

Chapter 1: General Description

Introduction	1
Technical Specifications	2

Chapter 2: Installation

Equipment Supplied	3
Unpacking Your Disc Memory	3
Configuring Power	4
Setting the Line Voltage Select Switches	4
Fuses	4
Power Cords	5
Interfacing the Disc Memory to Your System	5
Selecting the Device Address	5
HP-IB Interface Restrictions	7

Chapter 3: Basic Operation

HP 9133A/B Basic Operation	10
3 1/2-inch Flexible Disc Usage and Handling	10
3 1/2-inch Flexible Disc Description and Write Protection	13
Inserting and Removing the 3 1/2-inch Flexible Disc	14
Media Wear Indication	15
9133A/B Controls and Indicators	16
Applying Power to the 9133A/B	17
3 1/2-inch Flexible Disc Structure	17
Data Errors	17
Selftest	17
HP 9134A/B Basic Operation	19
9134A/B Controls and Indicators	19
Applying Power to the 9134A/B	20
HP 9135A Basic Operation	21
5 1/4-inch Flexible Disc Usage and Handling	21
5 1/4-inch Flexible Disc Write Protection	25
Inserting and Removing the 5 1/4-inch Flexible Disc	26
Controls and Indicators	27
Applying Power to the 9135A	28

Chapter 4: Maintenance and Service

Maintenance	29
Service	29
Warranty	29
Cleaning the Case	30

Table of Contents

Appendix A: Helpful Hints

Introduction	31
Series 100	31
Series 200	31
The Winchester Drive	31

Figures

1-1 HP 9133A/B, HP 9134A/B, and HP 9135A Disc Memories	1
2-1 Line Voltage Select Switches	4
2-2 Available Power Cords	5
2-3 Device Address Switch Setting	6
2-4 HP-IB Interface Cables	7
2-5 Interface Connection	8
3-1 3 1/2-inch Flexible Disc Head/Media Contaminants	11
3-2 The 3 1/2-inch Flexible Disc	14
3-3 3 1/2-inch Flexible Disc Write Protection	14
3-4 3 1/2-inch Flexible Disc Insertion	15
3-5 9133A/B Controls and Indicators	16
3-6 9134A/B Controls and Indicators	19
3-7 5 1/4-inch Flexible Disc Head/Media Contaminants	22
3-8 Defective 5 1/4-inch Flexible Disc	25
3-9 5 1/4-inch Flexible Disc Write Protection	25
3-10 5 1/4-inch Flexible Disc Insertion	26
3-11 5 1/4-inch Flexible Disc Structure	27
3-12 9135A Controls and Indicators	27
A-1 Winchester Drive With and Without Option 010	32

Tables

2-1 Fuses	4
-----------------	---

Chapter 1

General Description

- Introduction
- Technical Specifications

Introduction

The HP 9133A/B, 9134A/B, and 9135A disc memories (Figure 1-1) are random access data storage devices. The 9133A contains a 4.6 Mbyte, 5 1/4-inch Winchester disc drive and a 3 1/2-inch flexible disc drive. The 9134A contains a 4.6 Mbyte, 5 1/4-inch Winchester drive only, and the 9135A contains a 4.6 Mbyte, 5 1/4-inch Winchester drive and a 5 1/4-inch flexible disc drive.

The Winchester drive, found in the 9133A, 9134A and 9135A disc memories, has been designed to emulate an HP 9895A 8-inch flexible disc drive master with three slave drives (1.15 Mbytes per drive). The 3 1/2-inch flexible disc drive in the 9133A is a 9121S, and the 5 1/4-inch flexible disc drive in the 9135A is an 82902M. Thus, HP computers that support the 9895A, 9121S and 82902M flexible disc drives can operate the 9133A, 9134A, and 9135A.

A 10 Mbyte Winchester drive is installed in the 9133B and 9134B disc memory products. The 9133B contains the same 3 1/2-inch flexible disc drive as the 9133A. The 10 Mbyte Winchester drive is only available in the single volume version.

Option 010 on all three devices consists of a modification to the Winchester controller printed circuit assembly which causes the Winchester drive to appear as one large 4.8 Mbyte volume. The Winchester with option 010 responds to most of the commands used on the 9895A flexible disc drive.

Refer to the Helpful Hints section at the back of this Manual for additional information on using the disc memory with your mainframe. For more information, refer to your Mass Storage Manual for programming information for the HP 9121S, 82902M and 9895A flexible disc drives.

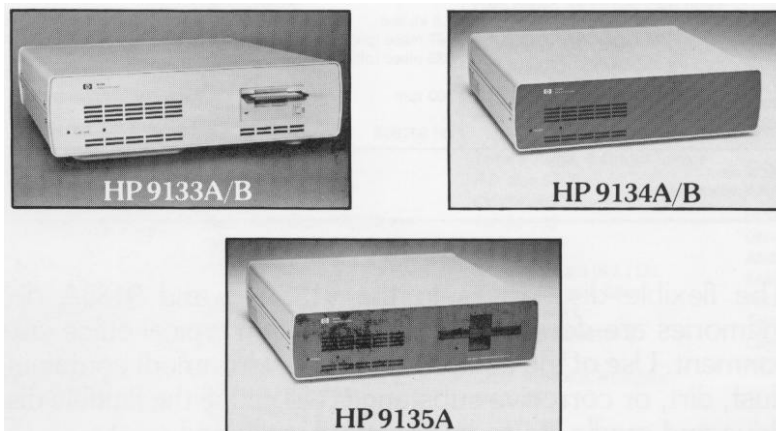

Figure 1-1. HP 9133A/B, HP 9134A/B, and HP 9135A Disc Memories

Technical Specifications

Listed below are the physical, electrical, and environmental specifications for the HP 9133A/B, 9134A/B and 9135A disc memories.

Unit Specifications

Power Requirements	9133A/B	9134A/B	9135A
Source (selected by rear panel switch)	100 Vac \pm 10% 120 Vac \pm 10% 220 Vac \pm 10% 240 Vac \pm 10%	100 Vac \pm 10% 120 Vac \pm 10% 220 Vac \pm 10% 240 Vac \pm 10%	100 Vac \pm 10% 120 Vac \pm 10% 220 Vac \pm 10% 240 Vac \pm 10%
Line Frequency (\pm 2%)	48-66 Hz	48-66 Hz	48-66 Hz
Power Consumption (max)	140W	140W	140W
Environmental Range			
Operating Temperature	10° to 40° C (50° to 140° F)	10° to 40° C (50° to 140° F)	10° to 40° C (50° to 140° F)
Storage Temperature	-40° to 60° C (-40° to 140° F)	-40° to 60° C (-40° to 140° F)	-40° to 60° C (-40° to 140° F)
Operating Humidity (non-condensing) 25.5° C max wet bulb temperature	20% to 80%	8% to 80%	20% to 80%
Storage Humidity (non-condensing)	5% to 95%	5% to 95%	5% to 95%
Operating Altitude	0 to 4572m 0 to 15000 ft	0 to 4572m 0 to 15000 ft	0 to 4572m 0 to 15000 ft
Size/Weight			
Height	130mm (5.1 in)	130mm (5.1 in)	130mm (5.1 in)
Width	424mm (16.7 in)	424mm (16.7 in)	424mm (16.7 in)
dual			
single			
Depth	475mm (18.7 in)	475mm (18.7 in)	475mm (18.7 in)
Net Weight	14.5 kg (32 lbs)	13.4 kg (29.5 lbs)	15.5 kg (34.1 lbs)
dual			
single			
Shipping Weight	17.6 kg (38.9 lbs)	16.8 kg (37 lbs)	18.6 kg (41 lbs)

Drive Specifications

Technical	3½" Flexible Disc	5¼" Flexible Discs	5 Mbyte Winchester	10 Mbyte Winchester
	9133A/B	9135A	9134A,9135A 9133A/B	9133B,9134B
Formatted Capacity:				
Bytes per Unit	270K	270K	4.6M	9.68M
Bytes per Sector	256	256	4.8M (Opt. 010)	9.68M
Sectors per Track	16	16	256	256
Tracks per Surface	66	33	30 (31 for Opt. 010)	31
			150 (152 for Opt. 010)	305
Tracks per Inch	135/in	48/in	255/in	345
Recording Format	dbl density	dbl density	---	---
Max Sustained Transfer Rate*	17.8 kb/sec	6.8 kb/sec	50 kb/sec	50 kb/sec
Average Access Time	415 msec (on) 1415 msec (off)	187 msec (on) 435 msec (off)	168 msec**	90 msec
Rotational Speed	600 rpm	300 rpm	3600 rpm	3600 rpm
Media Part Number (10 pack)	HP 92191A	HP 92190A	---	---

* Mainframe dependent
** 60 msec within 1 volume

NOTE

The flexible disc drives in the 9133A/B and 9135A disc memories are designed for operation in a typical office environment. Use of the equipment in an environment containing dust, dirt, or corrosive substances will cause the flexible disc drive and media life to be drastically reduced.

Chapter 2

Installation

- **Equipment Supplied**
- **Unpacking Your Disc Memory**
- **Configuring Power**
- **Interfacing the Disc Memory to Your System**

Equipment Supplied

Please check to insure that you have received all of the standard equipment. If any items are incorrect or missing, please contact the dealer from whom you purchased the unit.

Description	Quantity	Voltage Range	HP Part Number
Power Cable	1		Dependent on location
Operator's Manual	1		09133-90000
Fuse	1	100 & 120Vac 2.5 Amp	2110-0083
	1	220 & 240Vac 1.5 Amp	2110-0043
Flexible Disc Media (with 9135A only)	1		9164-0128

A package of ten 3 1/2-inch discs can be ordered for your 9133A/B using the 92191A product number.

A package of ten 5 1/4-inch discs can be ordered for your 9135A using the 92190A product number.

Unpacking Your Disc Memory

Your disc memory was carefully inspected before shipment. Remove the unit from the shipping carton and carefully inspect the unit for any physical damage that may have occurred during shipment. If you find any damage, you should immediately notify your dealer and file a claim with any carriers involved.

CAUTION

THE DISC MEMORY IS A PRECISION INSTRUMENT. MECHANICAL SHOCK CAN MISALIGN THE READ/WRITE HEADS, RESULTING IN READ ERRORS AND/OR DAMAGED DISCS WHETHER THE DISC IS OPERATING OR NOT.

If the disc memory is moved, be careful when picking it up and setting it down.

Carefully repack the disc memory in the original shipping carton before transporting it to another site.

CAUTION

EVIDENCE OF EXCESSIVE MECHANICAL SHOCK WILL VOID
THE WARRANTY.

Configuring Power

The following information should be used to configure your disc memory device power for proper operation in your area.

Setting the Line Voltage Select Switches

The voltage select switches on the rear panel must be set to the nominal line voltage for the area in which it is operating. Figure 2-1 shows the setting of the voltage select switches for the various line voltages.

CAUTION

ALWAYS TURN OFF THE AC POWER SWITCH BEFORE
CHANGING THE VOLTAGE SELECT SWITCHES.

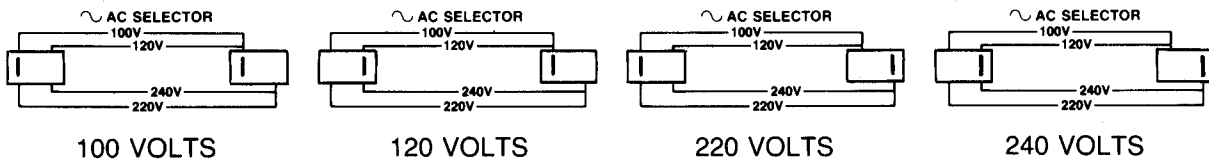

Figure 2-1. Line Voltage Select Switches

Fuses

A different fuse is required for each of the two voltage ranges of 110-120 and 220-240 Vac. Table 2-1 gives the correct fuse ratings and fuse part numbers.

Table 2-1. Fuses

Voltage Range	Fuse Rating	HP Part Number
100 & 120Vac	2.5V 250 Vac Normal Blow	2110-0083
220 & 240Vac	1.5V 250 VAC Normal Blow	2110-0043

WARNING

ALWAYS DISCONNECT THE DISC MEMORY FROM THE
AC SOURCE BEFORE CHANGING FUSES.

Power Cords

Power cords supplied by HP have polarities matched to the power input socket on the equipment (Figure 2-2).

- * L = Line or active conductor (also called "live" or "hot")
- * N = Neutral or identified conductor
- * E = Earth or safety ground

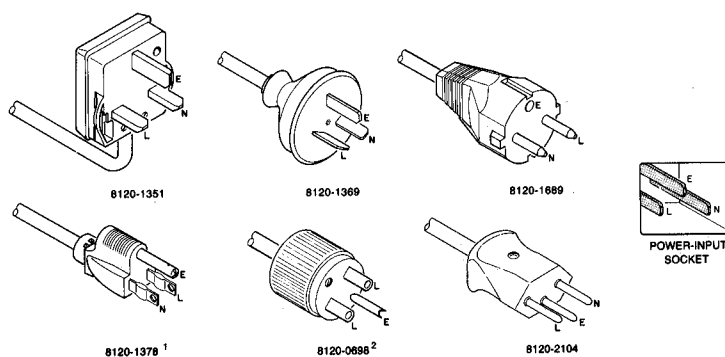

¹UL and CSA approved for use in the United States of America and Canada with equipment set for either 100 or 120 Vac operation.

²UL and CSA approved for use in the United States of America and Canada with equipment set for either 200 or 240 Vac operation.

Figure 2-2. Available Power Cords

WARNING

IF IT IS NECESSARY TO REPLACE THE POWER CORD, THE REPLACEMENT CORD MUST HAVE THE SAME POLARITY AS THE ORIGINAL. OTHERWISE, A SAFETY HAZARD MIGHT EXIST IF AN INTERNAL FAILURE OCCURS.

The cord packaged with the equipment depends upon where the equipment is to be delivered.

Interfacing the Disc Memory to Your System

The disc memory is connected to the computer via the Hewlett-Packard Interface Bus (HP-IB). The device address switches are set prior to connecting the interface cable.

Selecting the Device Address

Each device in an HP-IB system must be set to a unique device address. The 9134A/B disc memory contains one device, and the 9133A/B and 9135A disc memories contain two devices. A device address switch is provided for each device. See Figure 2-3 for switch locations.

Prior to setting the device address switches, turn the disc memory ~AC line switches OFF.

The switches can be set to any one of eight device addresses, ranging from decimal 0 through 7. Refer to Figure 2-3 to set these switches to the desired device address.

Switch Segments

Address	X	4	2	1	
0	X	UP	UP	UP	(Factory setting for Winchester)
1	X	UP	UP	DOWN	
2	X	UP	DOWN	UP	(Factory setting for flexible disc)
3	X	UP	DOWN	DOWN	
4	X	DOWN	UP	UP	
5	X	DOWN	UP	DOWN	
6	X	DOWN	DOWN	UP	
7	X	DOWN	DOWN	DOWN	

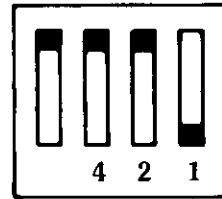

X = Not used

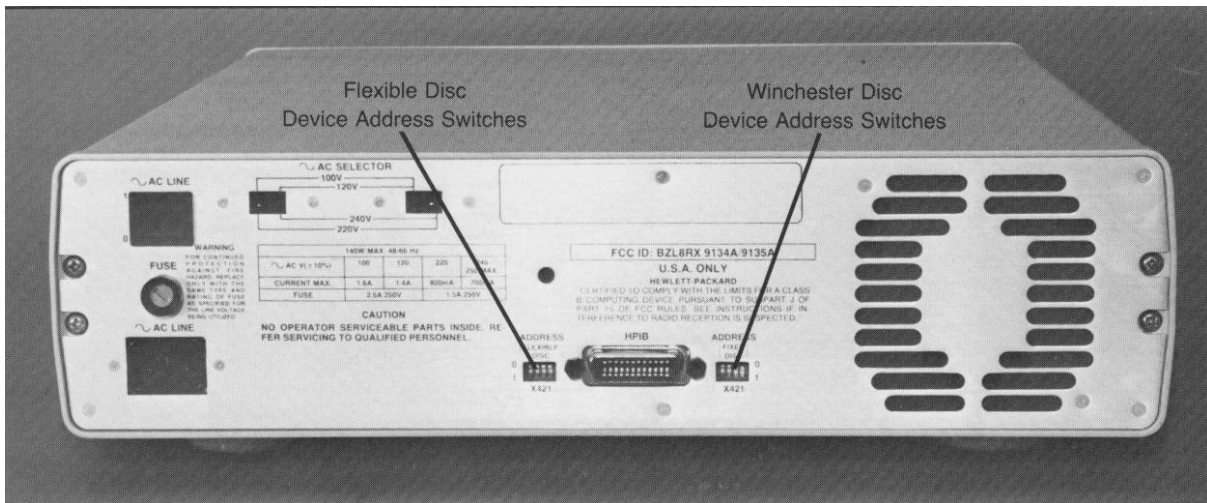

Figure 2-3. Device Address Switch Setting

CAUTION

ALWAYS SET THE AC LINE SWITCHES TO "OFF" (0) FOR THE COMPUTER AND THE DISC DRIVES WHEN INSERTING OR REMOVING THE INTERFACE CABLES. USE ONLY CABLES DESIGNED BY HEWLETT-PACKARD SPECIFICALLY FOR YOUR EQUIPMENT. FAILURE TO DO SO COULD DAMAGE THE DISC DRIVE OR THE CONTROLLING COMPUTER.

Refer to Figure 2-4 for a list of the HP-IB interface cables used with HP computers.

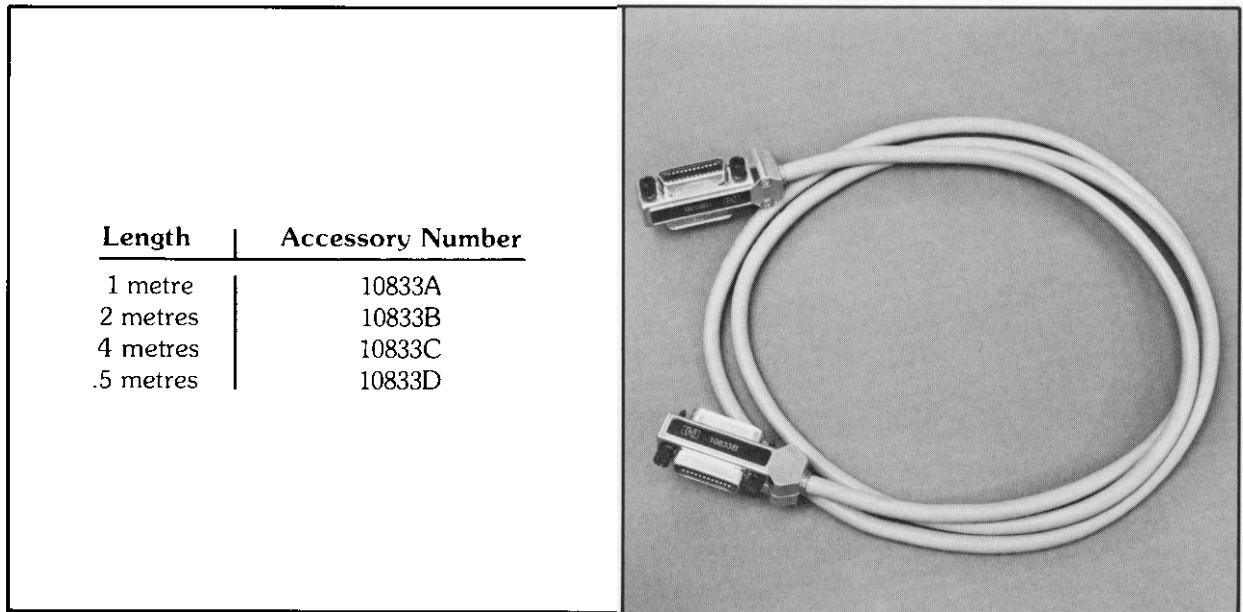

Figure 2-4. HP-IB Interface Cables

HP-IB Interface Restrictions

1. All the ~AC line switches must be turned "OFF" when connecting (and disconnecting) devices to your system.
2. The total length of cable permitted in one bus system must be less than or equal to two metres times the number of devices connected together (the interface card is counted as one device).
3. The total length of the cable must not exceed 20 metres. For example, a system containing six devices can be connected together with cables that have a total length less than or equal to 12 metres (six devices \times 2m/device = 12 metres). The individual lengths of cable can be distributed in any manner desired as long as the total length does not exceed the allowed maximum. If more than 10 devices are to be connected together, cables shorter than two metres must be used between some of the devices to keep the total cable length less than 20 metres.
4. The maximum number of devices that can be connected together in one bus system is 15. There are no restrictions to the way cables may be connected together; however, it is recommended that no more than four piggyback connectors be stacked together on one device. The resulting structure could exert enough force on the connector mounting to damage it.

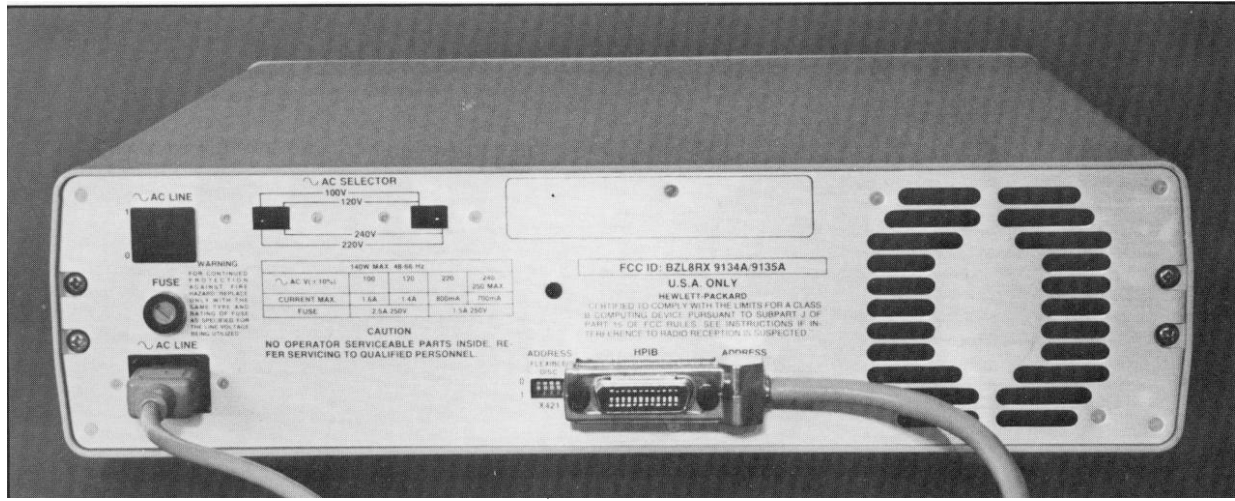

Figure 2-5. Interface Connection

Chapter 3

Basic Operation

HP 9133A/B Basic Operation

- 3 1/2-inch Flexible Disc Usage and Handling
- 3 1/2-inch Flexible Disc Description and Write Protection
- Inserting and Removing the 3 1/2-inch Flexible Disc
- Media Wear Indication
- 9133A/B Controls and Indicators
- Applying Power to the 9133A/B
- Selftest Procedures

HP 9134A/B Basic Operation

- 9134A/B Controls and Indicators
- Applying Power to the 9134A/B

HP 9135A Basic Operation

- 5 1/4-inch Flexible Disc Usage and Handling
- 5 1/4-inch Flexible Disc Write Protection
- Inserting and Removing the 5 1/4-inch Flexible Disc
- Controls and Indicators
- Applying Power to the 9135A

HP 9133A/B Basic Operation

3 1/2-inch Flexible Disc Usage and Handling
 3 1/2-inch Flexible Disc Description and Write Protection
 Inserting and Removing the 3 1/2-inch Flexible Disc
 Media Wear Indication
 9133A/B Controls and Indicators
 Applying Power to the 9133A/B
 Selftest Procedures

CAUTION

KEEP THE FRONT AND BACK OF THE DISC MEMORY FREE FROM OBSTRUCTIONS TO AVOID RESTRICTING THE AIR FLOW. FAILURE TO DO SO COULD CAUSE THE UNIT TO OVERHEAT AND RESULT IN DAMAGE TO THE DISC MEMORY.

3 1/2-inch Flexible Disc Usage and Handling

Flexible Disc Media

The removable storage medium used in the HP 9133A/B is a flexible mylar disc coated with a thin layer of magnetic oxide. The disc is enclosed in a protective plastic jacket with a slot for head access to the recording surface. Only the lower side of the flexible disc is used for data storage. The lower side refers to the lower side of the disc as it resides in the drive.

Each flexible disc must be initialized before it can be used for data storage. The initialization procedure marks each disc sector, checks for defective tracks, and establishes file directories.

Refer to your computer programming or mass storage manual for the correct initialization procedure.

CAUTION

DISC DRIVE PERFORMANCE AND RELIABILITY ARE DEPENDENT ON THE TYPE OF MEDIA USED. DISC DRIVE SPECIFICATIONS CAN BE ASSURED ONLY WHEN USING HP MEDIA. THE USE OF IMPROPER MEDIA CAN RESULT IN PREMATURE DISC FAILURE OR DAMAGE TO THE DISC DRIVE.

ON SOME DISC PRODUCTS HP MAY QUALIFY OTHER NON-HP MEDIA. WHEN TESTED, THIS MEDIA MET HP SPECIFICATIONS. HOWEVER, HP DOES NOT WARRANT OR SUPPORT THIS MEDIA AND CANNOT CONTROL CHANGES IN ITS SPECIFICATIONS OR QUALITY. THE SELECTION AND USE OF SUCH PRODUCTS IS THE CUSTOMER'S RESPONSIBILITY. HP RESERVED THE RIGHT TO EXCLUDE FROM WARRANTY AND MAINTENANCE AGREEMENT COVERAGE ANY REPAIRS WHICH HP REASONABLY DETERMINES OR BELIEVES WERE CAUSED BY THE USE OF MEDIA NOT DISTRIBUTED BY HP. HP WILL UPON REQUEST PROVIDE SUCH REPAIRS ON A TIME AND MATERIAL BASIS.

WARRANTY AND MAINTENANCE AGREEMENT COVERAGE
OF REPAIRS NOT CAUSED BY THE USE OF NON-HP MEDIA IS
UNAFFECTED.

Operating Cleanliness

The read/write head must maintain contact with the disc during read and write operations. Figure 3-1 shows various types of contaminants and their size relationships. A contaminant particle hard enough and of the right size may scratch the media oxide coating or the head surface. Even if not hard enough to scratch, it may be large enough to lift the head from the surface, causing data errors or damage to the media.

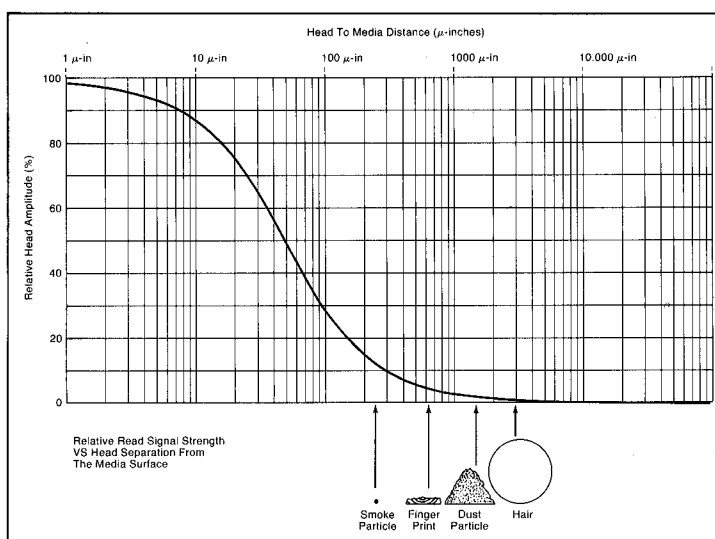

Figure 3-1. 3 1/2-inch Flexible Disc Head/Media Contaminants

Handling Flexible Disc Media

The flexible disc is basically maintenance free, but it is delicate and **MUST BE HANDLED CAREFULLY**. Remember, the disc contains your valuable data and programs, and should be treated accordingly. A good rule of thumb is to treat your disc as you would a valuable record album. Here are some specific Do's and Don'ts to avoid loss of data or damage to your discs.

EVEN A LITTLE CARELESSNESS IN DISC HANDLING CAN DRAMATICALLY REDUCE THE LIFE OF THE DISC.

Do

Back Up Discs Frequently

There is always a chance of losing data when mass storage devices are accessed. There are many causes in any computer system—a programming bug, operator error, power failure,

or hardware failure. In the case of flexible discs, media failure from contamination or wearout is possible. **YOUR BEST PROTECTION AGAINST DATA LOSS IS FREQUENT BACKUP OF YOUR FILES.**

Slide The Disc Guard Over The Head Window When Not In Use

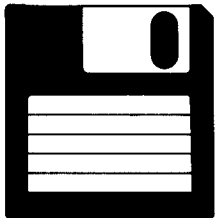

This is the single most important thing to remember about handling your disc because it prolongs disc life by protecting it from dust and scratches. **NEVER ATTEMPT TO BLOW DUST FROM THE DISC SURFACE.** Between uses discs should be stored upright in a dust-free container. The box in which the discs are shipped, or a similar container, is a good choice.

Operate Your System In A Clean Environment



Airborne contaminants and particles accidentally dropped onto the disc will cause your disc to wear out prematurely and may cause unreliable data storage and retrieval operations. Some of the most common contaminants are **DUST, SMOKE, ASHES, ERASER CRUMBS, and BREADCRUMBS.** Chemical vapors may also cause premature wear-out. **NEVER ATTEMPT TO BLOW SMALL PARTICLES FROM THE DISC SURFACE.**

Maintain Proper Temperature And Humidity

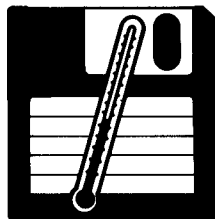

The proper operating range is 10°C (50°F) to 40°C (104°F) and 20% to 80% relative humidity. While temperature is usually easy to control, it may be necessary to make special provisions to keep the humidity in the proper range. Although the disc will continue to operate outside the normal humidity range, it will wear out more quickly and will have a higher error rate.

Avoid Magnetic Fields



The data is stored on the disc magnetically and can be erased by an external magnetic field. Avoid placing a disc near power transformers, magnets or large disc memories or motors.

Remove From Drive When Not In Use



Remove the disc completely from the drive when access is not needed for an extended period of time.

Use A Felt Tip Pen To Label Your Disc

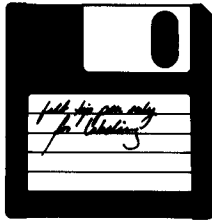

Use a soft felt tip pen to label your disc, and be careful to write only in the label area.

Replace Discs Frequently

Although discs are designed to provide many hours of useful life, they will eventually wear out. The life of a disc is VERY dependent on how carefully it is handled and how much it is used.

The following guidelines refer to head/media contact time or the time the disc access light on the front panel is lit. The terms used here (normally and heavily) also refer to the head load pad replacement requirements in the Maintenance section of Chapter 4. A disc used normally (disc access light is lit less than 20 minutes a day) should last half a year. A disc that is used heavily (disc access light lit more than 2 hours a day) should not be expected to last more than 2 months. Discs should be replaced whenever they begin to show signs of circular marring. See the following section titled "Media Wear Indication."

Don't

Do Not Touch The Surface Of The Disc



The thickness of a fingerprint is enough to lift the head off the disc and cause errors. The oils in a fingerprint will also collect dust which can cause a disc to wear out sooner than normal.

Do Not Bend Or Fold The Disc

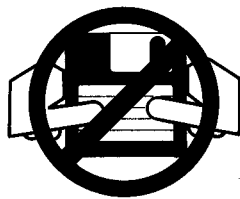

The disc is flexible but will not operate if it is creased. Using ball point pens, rubber bands, paper clips, etc. can crease the disc.

Do Not Try To Clean A Disc

The inside surface of the disc jacket is covered with a special material that cleans the disc as it rotates. Any other method of cleaning may cause solvent damage to the media or scratch the disc, causing loss of data. If a disc becomes dirty or scratched, immediately transfer the data to a new disc and dispose of the old disc.

3 1/2-inch Flexible Disc Description and Write Protection

The 3 1/2-inch flexible disc is enclosed in a rigid plastic shell for extra protection and reduced disc-to-case friction (see Figure 3-2). A metal centering hub ensures rapid and accurate positioning when the disc is inserted in the drive. The disc guard which slides back and forth across the front of the disc protects the recording surface from foreign object contamination.

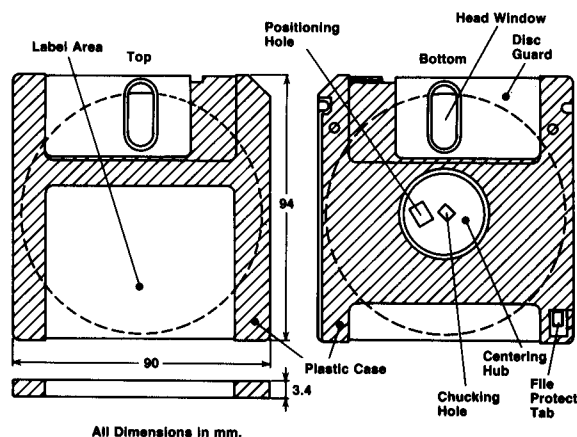

Figure 3-2. The 3 1/2-inch Flexible Disc

The micro-flexible disc is write unprotected when you receive it. To prepare the disc for write protected operation, do the following (see Figure 3-3):

1. Break off the write protect tab.
2. Align the protrusion on the tab with the slot in the disc
3. Depress the tab into the groove - tab should fit snugly.

Write protection is accomplished by sliding the tab away from the center of the disc.

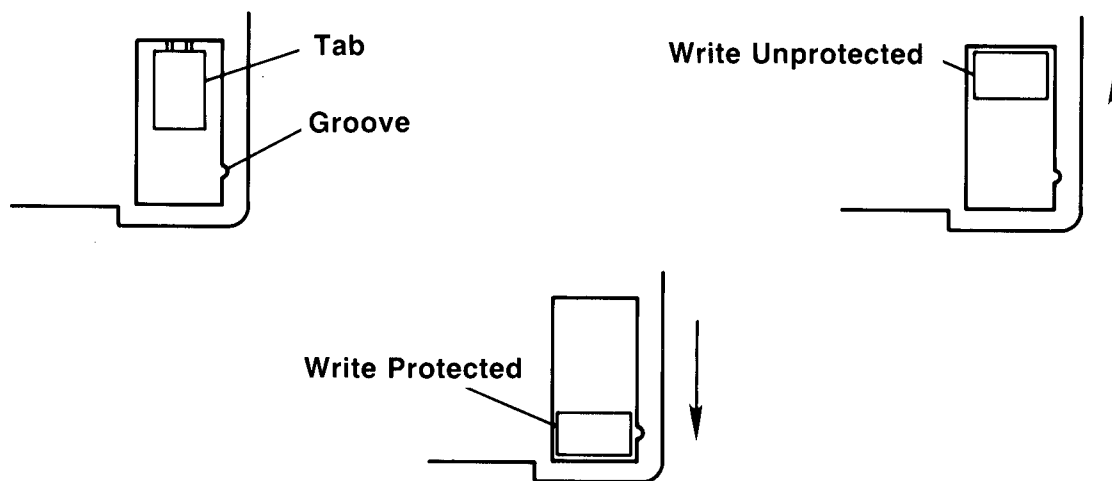

Figure 3-3. 3 1/2-inch Flexible Disc Write Protection

Inserting and Removing the 3 1/2-inch Flexible Disc

1. The disc can be inserted into the drive with or without power applied.
2. Slide the disc guard away from the head window exposing the disc surface. Insert the exposed head window first with the metal centering hub down. Carefully slide the disc into the drive until you feel it contact the rear of the drive.

Continue pressing the disc until it is pulled down into the drive.

3. Remove the disc by depressing the disc eject button and pulling the disc straight out. Always slide the disc guard over the head window immediately after removing the disc from the drive.

Refer to Figure 3-4 for proper insertion of the flexible disc.

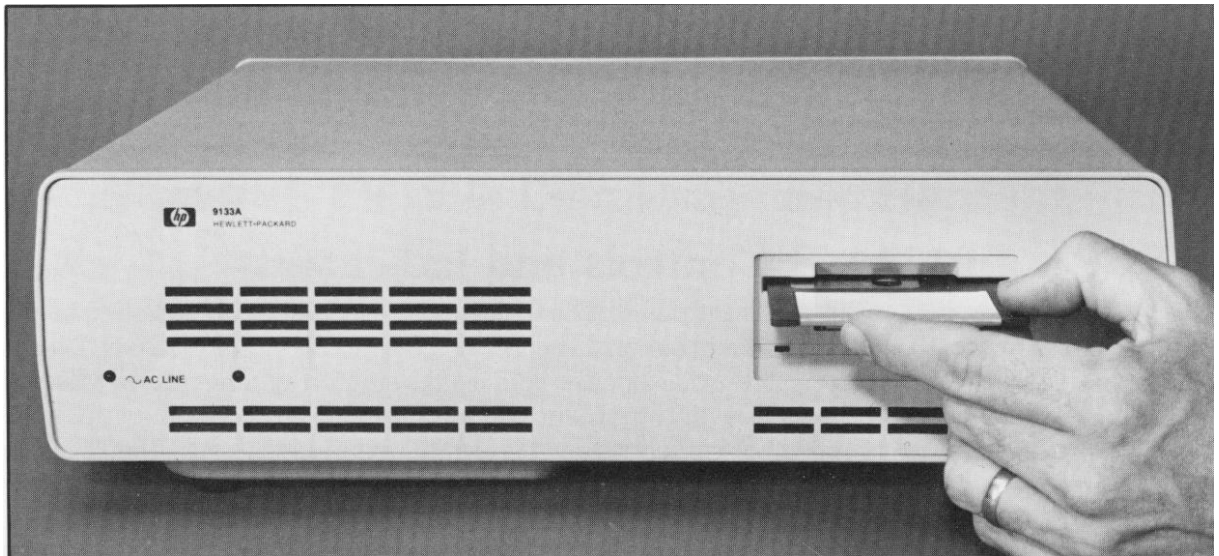

Figure 3-4. 3 1/2-inch Flexible Disc Insertion

NOTE

There is no write protect capability on the Winchester drive. Caution must be used to avoid writing over data stored on the Winchester disc.

Media Wear Indication

As the flexible disc becomes worn, the friction between the disc and the read/write head increases. Because the same read/write head accesses the data from all your discs, it is very important that this friction be kept to a minimum level. To insure the long wear life of the read/write head, you should make the following check each time you insert a disc into your drive.

Checking for wear is a simple visual inspection of the disc surface before you insert the disc into the drive. When viewing the disc surface you should look for any signs of circular marring. This is done by sliding open the disc guard revealing the disc surface. If you see any sign of circular marring on either side of the exposed surface, the disc should be immediately copied and discarded. Circular marring generally occurs first on the upper (label side) surface of the disc. This may indicate load pad wear.

Compare a new (never used) disc to a disc you have used for a few hours. There should be no visible difference.

An internal test has been implemented and provides you with an upper limit indication for disc use. When a disc reaches a finite limit, the head loaded indicator (disc access light) blinks on and off. This indication is continued until you remove the disc or until the host sends a command to the drive. The drive accepts and performs the command from the host, after which it resumes the disc “worn out” indication. At this time the data on the disc should be copied to a new disc and the old disc discarded. Continued use of the old disc after the initial wear indication will result in eventual automatic write protection of the disc by the drive controller.

Viewing the disc in the above manner prior to inserting the disc into the drive and taking the appropriate action when you receive the wearout indication will insure the long life of the read/write head.

9133A/B Controls and Indicators

The indicators are located on the front panel. The indicators, as shown in Figure 3-5, are a disc access light for the Winchester drive and the head load indicator for the 3 1/2-inch flexible disc drive. The Winchester drive access light is illuminated whenever the disc is accessed for data storage or retrieval and momentarily when the drive is powered-up. The flexible disc drive access light lights up whenever the head is loaded or when the drive is selected.

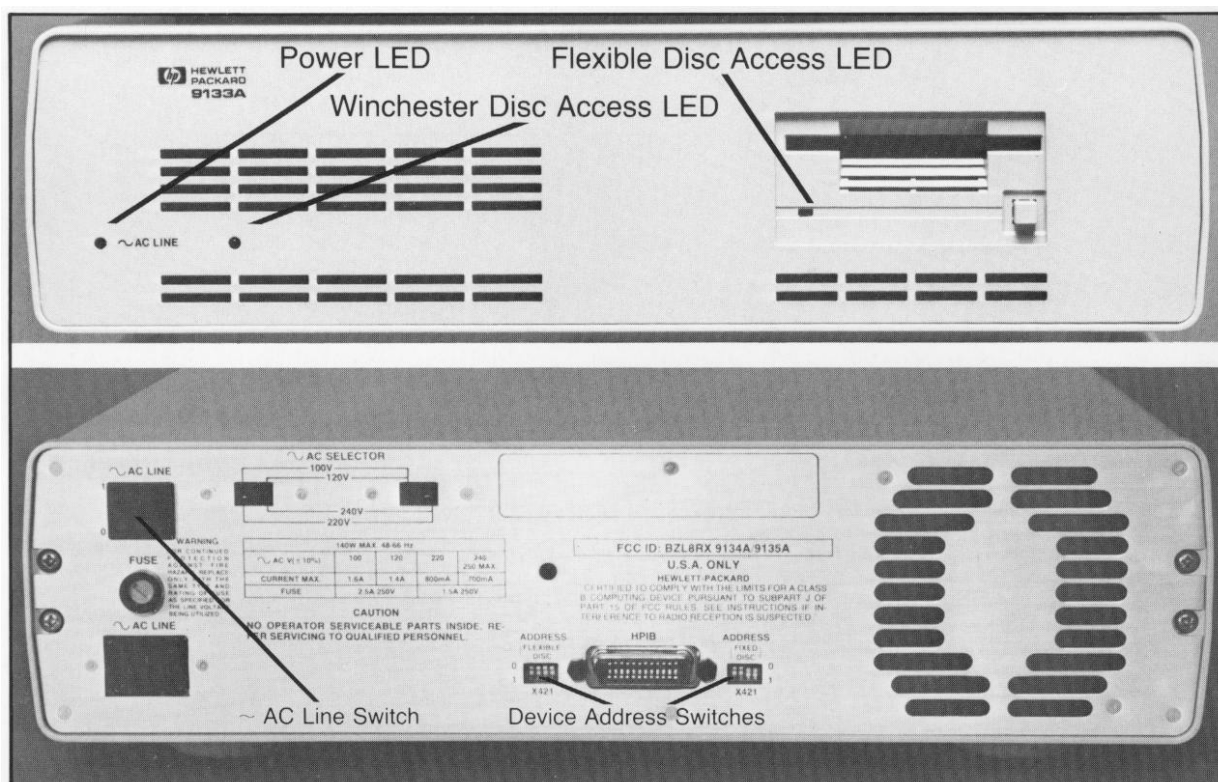

Figure 3-5. 9133A/B Controls and Indicators

CAUTION

THE FLEXIBLE DISC ACCESS LIGHT ON THE FRONT OF THE DRIVE INDICATES USAGE OF THAT DRIVE. DO NOT DEPRESS THE DISC EJECT BUTTON WHEN THE ACTIVITY LIGHT IS ON.

Applying Power to the 9133A/B

Before turning the disc memory power on, be sure to perform all the procedures in Chapter 2.

Locate the AC line switch on the rear panel and set it to the "ON" or "1" position. The disc drive requires about 20 seconds after the application of power before it is ready for operation. See the section titled "Selftest" in this chapter for the power-on selftest indication.

3 1/2-inch Flexible Disc Structure

The surface of the flexible disc is coated with ferromagnetic iron oxide. Data is stored in the form of binary digits represented by magnetic flux reversals on the disc. Information is stored and retrieved by the disc unit's head which comes in contact with the disc's lower surface.

Information is stored in 70 concentric tracks on the lower side of the disc. The tracks are numbered 0 through 69. Each track is divided into 16 physical records (sectors), numbered 0 through 15. Each record contains 256 bytes (characters) of information. There is an important difference between a physical record and a logical record. A physical record is the smallest accessible unit of data on the disc. It is always the same size (256 bytes). A logical record is one that you define when you create a data file. Data files are variable and depend on the type and quantity of data you are storing.

Some of the space on each disc is reserved for the directory. The space reserved depends on the controlling computer and the number of records in the file directory.

Data Errors

Two error conditions cause the selftest indicator to come on and stay on until the condition disappears. These conditions are a command sequence-error over the HP-IB (from the host controller) and a data error from the disc. Whenever these conditions occur it is best to retry the last operation. If a retry is successful, the error and error indication are cleared. If the condition remains after several retries, contact your dealer or sales office for assistance.

Selftest

There are three selftest modes on the flexible disc within the 9133A/B: power-on, remote, and service selftests. The service selftests are not included in this document.

The self test light is visible through a hole in the rear of the 9133A/B. See Figure 3-5 for the location of this light.

The power-on test exercises the RAM and the flexible disc controller chip (FDC). Power-on also calculates a checksum for the ROM. If the RAM or ROM tests fail, the processor goes no further, waiting for service. If the 9133A/B passes the RAM and ROM tests, but fails the FDC

test, the flexible disc controller processor continues to initialize the system and allows the host to talk to it, if possible. If all the power-on selftests are passed, the self test light flashes five times to indicate a successful power-on condition.

The remote selftest is initiated by the host with the proper HP-IB passed command. Results of the test are available over the HP-IB with this test. See the INITIATE SELFTEST command description in the Service Manual for more details. If the drive contains a disc that is not write protected, the following tests are performed: RAM, ROM, FDC, motor speed, format, and read verify test is executed. The RAM test reads and writes checkerboard patterns into the RAM. The ROM test calculates a checksum for the ROM and compares that to a precalculated value. The FDC test reads and writes to selected registers on the chip. The motor speed test measures the index period and compares it to the drive specification. The format test formats the discs in the drive. No testing of the interface to the host occurs.

WARNING

ALL DATA ON THE DISC IS DESTROYED AND IS UNRECOVERABLE WHEN PERFORMING THE REMOTE SELFTEST.

The read test verifies the written data and the error checking of this data on the discs. If all the other tests are passed successfully, the self test light flashes ten times. If any test fails, no flashing occurs.

If the disc inserted into the drive is write protected, the format test is skipped. If all the other tests are passed successfully, the self test light flashes ten times. If no disc is inserted into the drive, then motor speed, format, and read tests are skipped. If the other tests are passed, the self test light flashes ten times.

After the remote selftest, the drive is reset and the flexible disc drive appears, to the host, to have just been powered-on.

HP 9134A/B Basic Operation

9134A/B Controls and Indicators
Applying Power to the 9134A/B

NOTE

There is no write protect capability on the Winchester drive. Caution must be used to avoid writing over data stored on the Winchester disc.

CAUTION

KEEP THE FRONT AND BACK OF THE UNIT FREE FROM OBSTRUCTIONS TO AVOID RESTRICTING THE AIR FLOW. FAILURE TO DO SO COULD CAUSE THE UNIT TO OVERHEAT AND RESULT IN DAMAGE TO THE DISC MEMORY.

HP 9134A/B Controls and Indicators

The indicators are located on the front panel. The indicators, as shown in Figure 3-6, are the power-on light, and the Winchester disc drive access light. The disc access light is illuminated whenever the disc is accessed for data storage or retrieval.

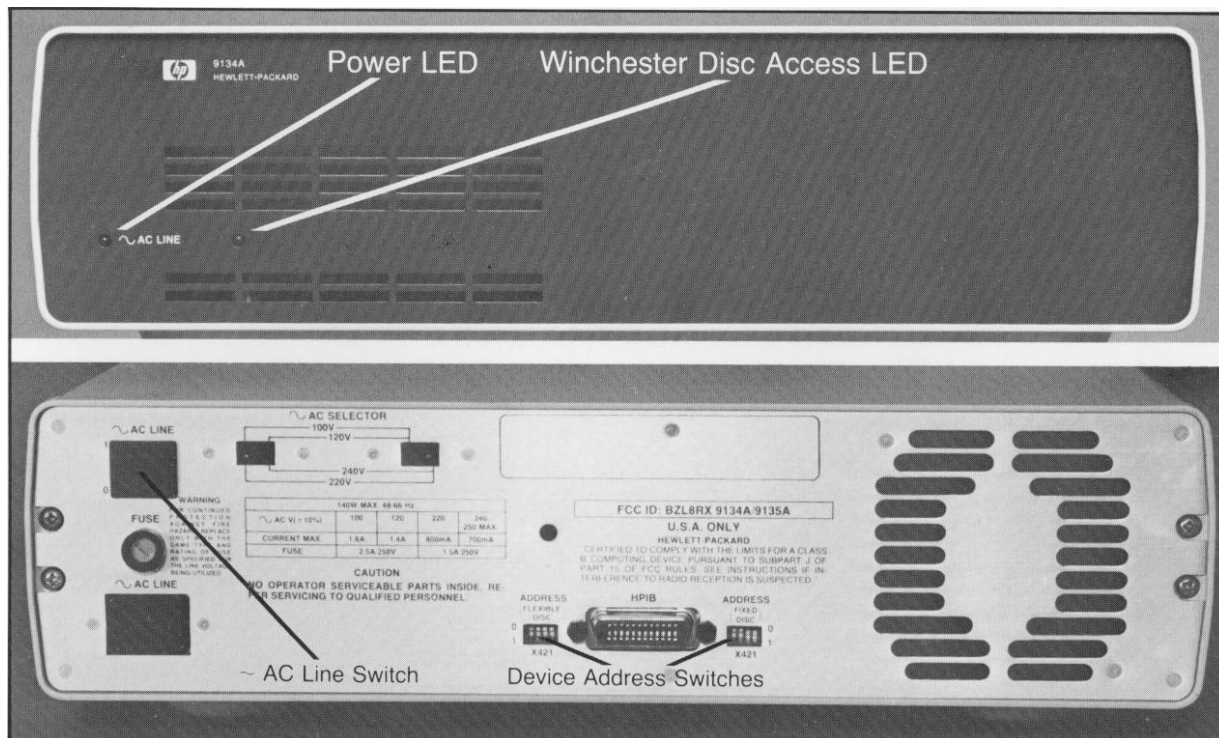

Figure 3-6. 9134A/B Controls and Indicators

Applying Power to the 9134A/B

Before turning the disc memory on, be sure to perform all the procedures in Chapter 2. Locate the ~AC line switch on the rear panel and set it to the "ON" or "1" position. The Winchester disc drive requires about 20 seconds after the application of power before it is ready for operation.

HP 9135A Basic Operation

5 1/4-inch Flexible Disc Usage and Handling
 5 1/4-inch Write Protection
 Inserting and Removing the 5 1/4-inch Flexible Disc
 9135A Controls and Indicators
 Applying Power to the 9135A

CAUTION

KEEP THE FRONT AND BACK OF THE UNIT FREE FROM OBSTRUCTIONS TO AVOID RESTRICTING THE AIR FLOW. FAILURE TO DO SO COULD CAUSE THE UNIT TO OVERHEAT AND RESULT IN DAMAGE TO THE DISC MEMORY.

5 1/4-inch Flexible Disc Usage and Handling

Flexible Disc Media

The removable storage medium used in the HP 9135A is a flexible mylar disc coated with a thin layer of ferromagnetic oxide. The disc is enclosed in a protective plastic jacket with a slot for head access.

Up to 270 Kbytes of data can be stored on each disc. Since some storage is used for a directory, the exact amount available for user storage depends upon the controller and the number of files stored. Refer to the appropriate mainframe mass storage programming or reference manual for details.

Each flexible disc must be initialized before it can be used for data storage. The initialization procedure marks each disc sector, checks for defective tracks, and may establish file directories. Refer to the mainframe programming or reference manual for the correct initialization procedure.

CAUTION

DISC DRIVE PERFORMANCE AND RELIABILITY ARE DEPENDENT ON THE TYPE OF MEDIA USED. DISC DRIVE SPECIFICATIONS CAN BE ASSURED ONLY WHEN USING HP MEDIA. THE USE OF IMPROPER MEDIA CAN RESULT IN PREMATURE DISC FAILURE OR DAMAGE TO THE DISC DRIVE.

ON SOME DISC PRODUCTS HP MAY QUALIFY OTHER NON-HP MEDIA. WHEN TESTED, THIS MEDIA MET HP SPECIFICATIONS. HOWEVER, HP DOES NOT WARRANT OR SUPPORT THIS MEDIA AND CANNOT CONTROL CHANGES IN ITS SPECIFICATIONS OR QUALITY. THE SELECTION AND USE OF SUCH PRODUCTS IS THE CUSTOMER'S RESPONSIBILITY. HP RESERVED THE RIGHT TO EXCLUDE FROM WARRANTY AND MAINTENANCE AGREEMENT COVERAGE ANY REPAIRS WHICH HP REASONABLY DETERMINES OR BELIEVES WERE CAUSED BY THE USE OF MEDIA NOT PROVIDED BY HP. HP WILL UPON REQUEST PROVIDE SUCH REPAIRS ON A TIME AND MATERIAL BASIS.

WARRANTY AND MAINTENANCE AGREEMENT COVERAGE
OF REPAIRS NOT CAUSED BY THE USE OF NON-HP MEDIA IS
UNAFFFECTED.

HP offers a package of ten 5 1/4-inch flexible discs for the HP 9135A (HP part number 92190A). Contact your dealer or nearest HP sales office for instructions on how to order this package.

Operating Cleanliness

The read/write heads must maintain contact with the disc during read and write operations. Figure 3-7 shows various types of contaminants and their size relationships. A contaminant particle hard enough and of the right size may scratch the media oxide coating or the head surface. Even if not hard enough to scratch, it may be large enough to lift the head from the surface, causing data errors or damage to the media.

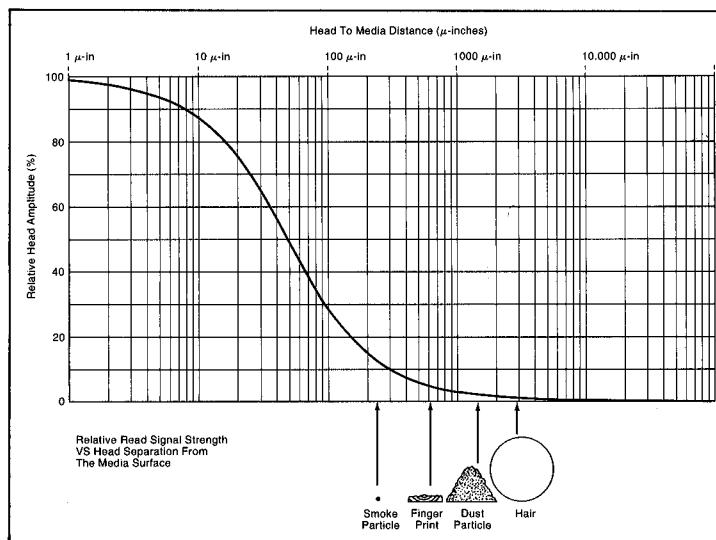

Figure 3-7. 5 1/4-inch Flexible Disc Head/Media Contaminants

Handling Flexible Disc Media

The flexible disc is basically maintenance free, but it is delicate and **MUST BE HANDLED CAREFULLY**. Remember, the disc contains your valuable data and programs and should be treated accordingly. A good rule of thumb is to treat your disc as you would a valuable record album. Here are some specific Do's and Don'ts to avoid loss of data or damage to your discs.

EVEN A LITTLE CARELESSNESS IN DISC HANDLING CAN DRAMATICALLY REDUCE THE LIFE OF THE DISC.

Do

Back Up Discs Frequently

There is always a chance of losing data when mass storage devices are accessed. There are many causes in any computer system—a programming bug, operator error, power failure, or hardware failure. In the case of flexible discs, another mode is possible—media failure from contamination or wearout. **YOUR BEST PROTECTION AGAINST DATA LOSS IS FREQUENT BACKUP OF YOUR FILES.**

Return Disc To Storage Envelope When Not In Use

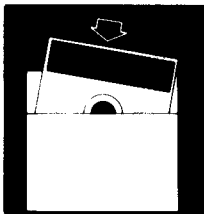

This is the single most important thing to remember about handling your disc because it prolongs disc life by protecting it from dust and scratches. Between uses discs should be stored upright in a dust-free container. The box in which the discs are shipped, or a similar container, is a good choice.

Operate Your System In A Clean Environment

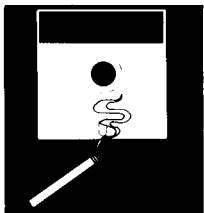

Airborne contaminants and particles accidentally dropped onto the disc will cause your disc to wear out prematurely and may cause unreliable data storage and retrieval operations. Some of the most common contaminants are **DUST, SMOKE, ASHES, ERASER CRUMBS, and BREADCRUMBS**. Chemical vapors may also cause premature wearout.

Maintain Proper Temperature And Humidity

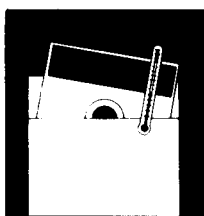

The proper operating range is 10°C (50°F) to 40°C (104°F) and 20% to 80% relative humidity. While temperature is usually easy to control, it may be necessary to make special provisions to keep the humidity in the proper range. Although the disc will continue to operate outside the normal humidity range, it will wear out more quickly and will have a higher error rate.

Avoid Magnetic Fields



The data is stored on the disc magnetically and can be erased by an external magnetic field. Avoid placing a disc near power transformers, magnets or large disc memories.

Remove Disc From Drive When Not In Use

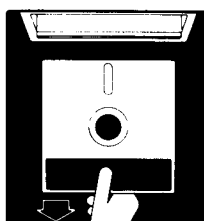

Remove the disc completely from the drive when access is not needed for an extended period of time.

Use A Felt Tip Pen To Label Your Disc

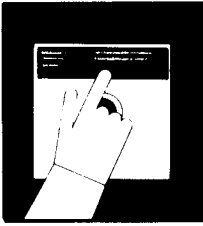

Use a soft felt tip pen to label your disc, and be careful to write only in the label area. Avoid the exposed media while labeling the disc. If possible, write on the large labels provided BEFORE applying them to the disc.

Replace Discs Frequently

Although discs are designed to provide several million revolutions of useful life, they will eventually wear out. The life of a disc is VERY dependent on how carefully it is handled and how much it is used. A disc used sparingly (less than 20 minutes a day) should last over a year. A disc that is used heavily (more than 2 hours a day) should not be expected to last more than 3 months. Discs should be replaced every three months for a heavily used disc or at least once a year, even for lightly used discs. If you ever see visible signs of abrasion on the disc, do an immediate backup and discard the worn disc.

Don't

Do Not Touch The Surface Of The Disc

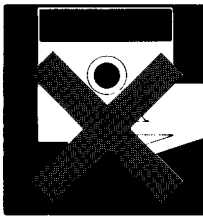

The thickness of a fingerprint is enough to lift the head off the disc and cause errors. The oils in a fingerprint will also collect dust which can cause a disc to wear out sooner than it normally would.

Do Not Bend Or Fold The Disc

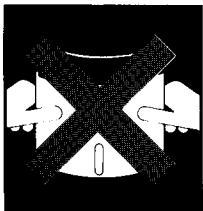

The disc is flexible but will not operate if it is creased. Using ball point pens, rubber bands, paper clips, etc. can crease the disc.

Do Not Try To Clean A Disc

The inside surface of the disc jacket is covered with a special material that cleans the disc as it rotates. Any other method of cleaning may cause solvent damage to the media or scratch the disc, causing loss of data. If a disc becomes dirty or scratched, immediately transfer the data to a new disc and dispose of the old disc.

NOTE

If you ever destroy media (if it looks anything like the photo in Figure 3-8, stop using the drive until it can be serviced. This is extremely important, as continued use of the drive may destroy more media. You should clean the drive heads immediately or call the nearest HP sales and service office (see the list in the back of this manual for the nearest office).



Figure 3-8. Defective 5 1/4-inch Flexible Disc

Write Protection

Data and programs stored on flexible discs can be protected from being written over (Figure 3-9). The disc is "write protected" by covering the write protect slot with a write protect tab (provided with the discs). This prevents you from writing any information on the disc. The disc can, however, be read normally. To write on a protected disc, remove the write protect tab from the write protect slot. Remember, fingerprints can be disastrous to your data, so do not touch the surface of the disc.

NOTE

There is no write protect capability on the Winchester drive. Caution must be used to avoid writing over data stored on the Winchester disc.

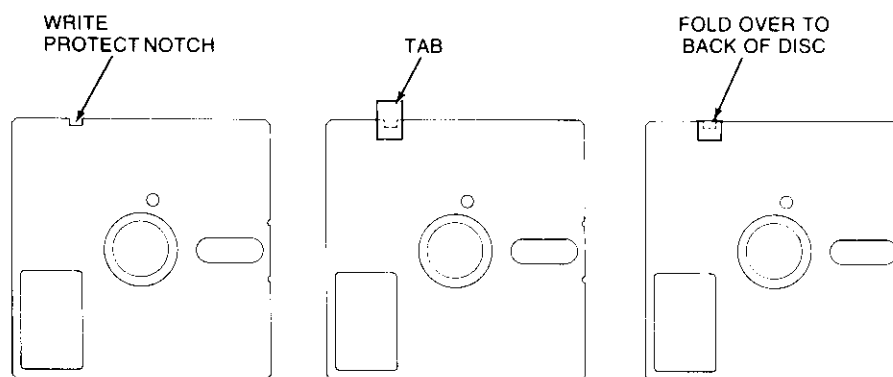

Figure 3-9. 5 1/4-inch Flexible Disc Write Protection

Inserting and Removing the 5 1/4-inch Flexible Disc

Refer to Figure 3-10 for proper insertion of the flexible disc in the HP 9135A.

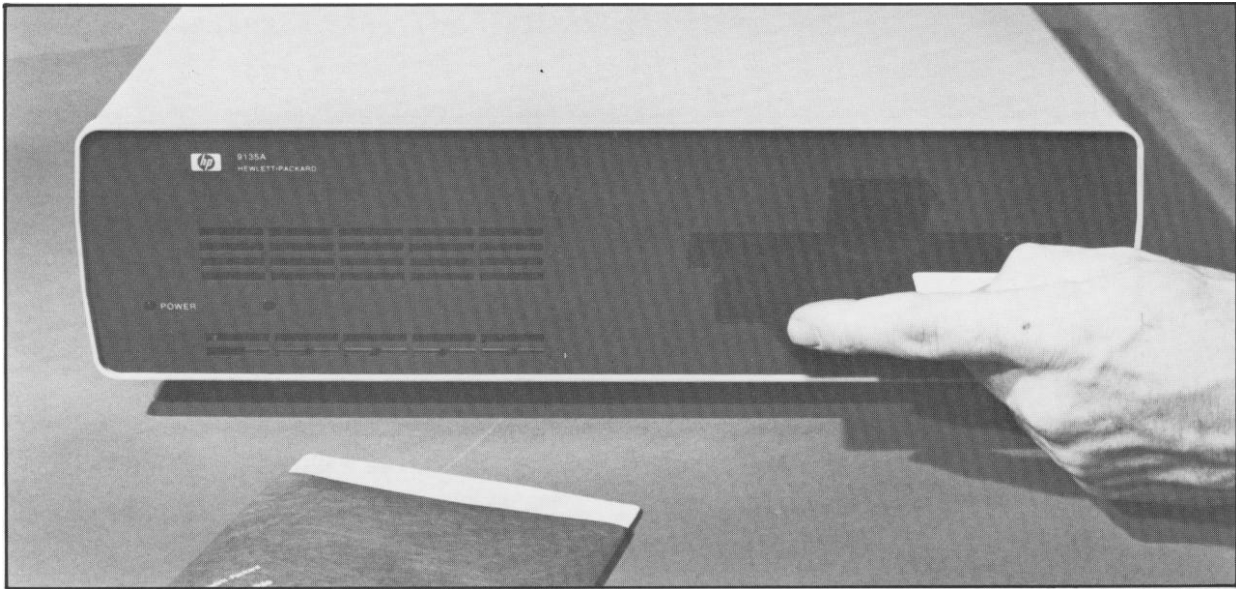

Figure 3-10. 5 1/4-inch Flexible Disc Insertion

To insert and remove flexible discs, perform these steps:

1. Open the door of the drive by pulling up on the drive latch.
2. Remove the disc from its protective envelope and carefully slide it into the drive until you feel it bottom out against the rear of the drive.
3. Close the door by pressing down on the drive latch. Never force the drive latch, as the media can be latched off center within the protective jacket. The disc can be installed with power on without harming the disc.
4. Remove the disc by pulling up on the drive latch and pulling straight out. Always store discs in their protective envelopes to ensure prolonged disc life.

5 1/4-inch Flexible Disc Structure

The surface of the flexible disc is coated with ferromagnetic oxide. Data is stored in the form of binary digits represented by magnetic flux reversals on the disc. Information is stored and retrieved by the disc unit's heads that come in contact with the disc's upper and lower surface.

Information is stored in 35 concentric tracks on each side of the disc (Figure 3-11). The tracks are numbered 0 through 34. Each track is divided into 16 physical records (sectors) numbered 0 through 15. Each record contains 256 bytes (characters) of information. There is an important difference between a physical record and a logical record. A physical record is the smallest accessible unit of data on the disc. It is always the same size (256 bytes). A logical record is one that you define when you create a data file. Its size is variable and depends on the type of data you are storing.

Some of the space on each disc is reserved for the directory. The amount reserved depends on the controlling computer and the number of records in the file directory.

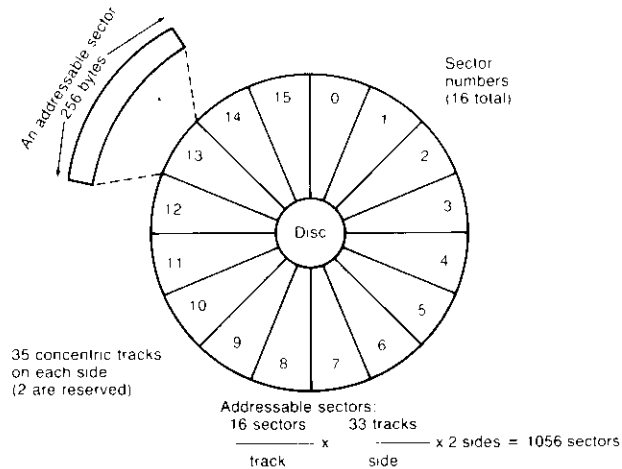

Figure 3-11. 5 1/4-inch Flexible Disc Structure

Controls and Indicators

The indicators are located on the front panel. The indicators, as shown in Figure 3-12, are the power-on light, the Winchester disc drive access light, and flexible disc access light. The disc access lights are illuminated whenever the disc is accessed for data storage or retrieval.

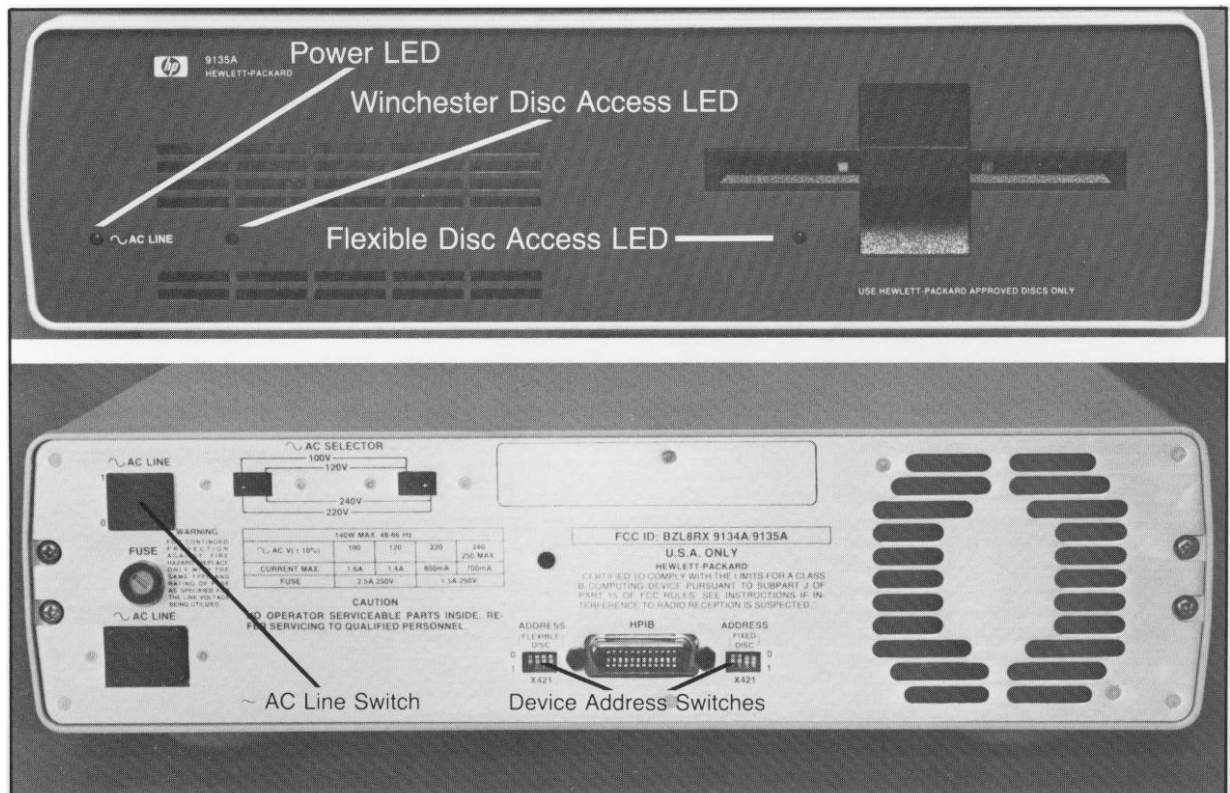

Figure 3-12. 9135A Controls and Indicators

Applying Power

Before turning the disc memory on, be sure to perform all the procedures in Chapter 2. Locate the ~AC line switch on the rear panel and set it to the "On" or "1" position. The Winchester disc drive requires about 20 seconds after the application of power before it is ready for operation.

Chapter 4

Maintenance and Service

- **Maintenance**
- **Service**
- **Warranty**
- **Cleaning the Case**

Maintenance

The disc memories in this family of products do not require regular maintenance.

9133A/B - The load pad on the 3 1/2-inch flexible disc drive will wear out over a period of time and must be replaced. Replacing this pad is a complicated process and should only be attempted by a trained service person.

The maintenance schedule for the load pad depends on the use of the drive. The interval for a drive in normal use is 5 years. A heavily-used drive should have its head load pad replaced every 1 to 2 years. Refer to the section titled "Replace Discs Frequently" for determining your drive usage.

9135A - In the event that media is destroyed in the 5 1/4-inch disc drive, a head cleaning kit is available for removing any debris remaining on the disc drive heads. The part number is 92193A.

The performance and life of the flexible disc heads and the flexible disc media depend directly on how carefully they are handled. Be sure to follow the disc care and handling guidelines presented in Chapter 3 and the environmental restrictions presented in the Specifications Table in Chapter 1.

Service

There are no operator serviceable parts in this family of discs. If you suspect that your disc memory is malfunctioning, call the HP sales office or dealer from which you purchased the unit.

Warranty

The complete warranty statement for the U.S. and Canada is included inside the front cover of this manual. For other countries, contact your local HP sales office or dealer from which you purchased your unit to determine warranty terms.

If you have questions concerning the warranty, please contact an authorized dealer or the HP sales and service office nearest you (see the back of this manual for nearest office).

Cleaning the Case

The disc memory case has been painted with a long-lasting, non-toxic, water-based paint. This paint will preserve the appearance of the unit for many years. To clean the case, use the following instructions to insure that you maintain the quality finish. If the case finish becomes damaged, consult the nearest HP sales and service office for touch-up paints that are available.



CAUTION

CHEMICAL SPRAY-ON CLEANERS USED FOR APPLIANCES AND OTHER HOUSEHOLD AND INDUSTRIAL APPLICATIONS MAY DAMAGE THE CASE FINISH. DO NOT USE CLEANERS THAT CONTAIN AMMONIA, BENZENES, CHLORIDES, OR ABRASIVES.



Dampen a clean, soft, lint-free cloth in a solution of clean water and mild soap. Wipe the soiled areas of the case, ensuring that no cleaning solution gets inside the unit. For cleaning more heavily soiled areas, a solution of 80% clean water and 20% isopropyl alcohol may be used. Wipe the areas that had cleaning solution applied with another clean, soft, lint-free cloth. A non-abrasive eraser may be used to remove pen and pencil marks.

Appendix A

Helpful Hints

Introduction

The following information is provided to help you avoid possible problems when operating the 9133A/B with Series 100 and 200 mainframes. Refer to your mass storage programming or reference manual for more information on the use of the disc memory with your mainframe.

Series 100

In the event that the error "CANNOT IDENTIFY ADDRESS 0" should appear on your Series 100 display, press the "LOAD OPS SYS" softkey (F6) to clear the error. This error will most likely occur on the power-up cycle of the system.

Series 200

(With Basic Operating System 2.1 or greater)

When entering the MSUS (Mass Storage Unit Specifier) on your Series 200 mainframe, specify "HP 9121" rather than "HP 82901" for optimum performance of the 3 1/2-inch flexible disc. When the MSUS is entered, the interleave is automatically set to 4 for the HP 82901, and set to 2 for the HP 9121.

Basic Operating Systems (prior to Basic 2.1) previously supplied with the 9826 and 9836 mainframes, when used with the series 200 mainframe, may not allow you to access the 3 1/2-inch flexible disc drive using the HP 9121 MSUS. The MSUS "HP 82901" will have to be used in these instances.

The Winchester Drive

The Winchester disc drive in the 9133A, 9134A and 9135A emulates a 9895A 8-inch flexible disc drive master and three 8-inch slave drives, each with 1.15 Mbytes of data storage capacity. All references to the 9895A in your mainframe mass storage manuals apply to the Winchester drive.

Option 010 of the 9133A, 9134A, and 9135A provides you with one large 4.8 Mbyte volume. The Winchester drive configured as one volume responds to the same commands as the four-volume version.

NOTE

Be aware that not all operating systems developed for your mainframe will support option 010 of the Winchester drive.

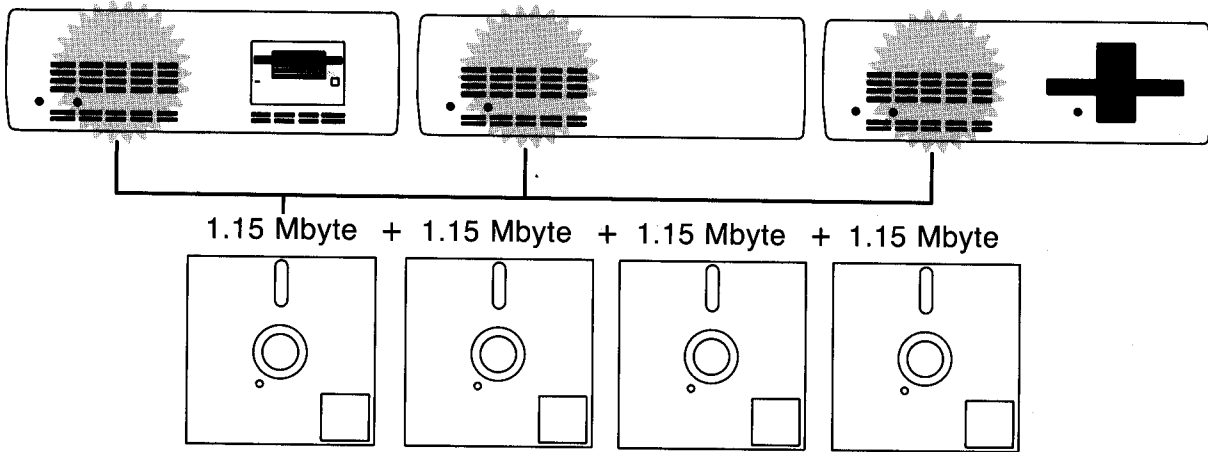

OR

One large 4.8 Mbyte Volume w/Option 010

OR

One large 10 Mbyte Volume (B versions)

Figure A-1. Winchester with and without Option 010

